



# X1-AC

# User Manual

3.0kw - 5.0kw



EN



## Solax Power Network Technology(Zhe jiang) Co., Ltd.

No.288 Shizhu Road, Tonglu Economic Development Zone,  
Tonglu City, Zhejiang province, China.

Tel: +86 0571-56260011

E-mail: info@solaxpower.com

614.00346.02

### Copyright Declaration

The copyright of this manual belongs to Solax Power Network Technology(Zhe jiang) Co., Ltd. Any corporation or individual should not plagiarize, partially or fully copy ( including software,etc.), and no reproduction or distribution of it in any form or by any means. All rights reserved. Solax Power Network Technology (Zhe jiang) Co.,Ltd.. reserves the right of final interpretation.

[www.solaxpower.com](http://www.solaxpower.com)

---

## Contents

<b>1 Note on this Manual</b> .....	<b>03</b>
1.1 Scope of Validity .....	03
1.2 Target Group .....	03
1.3 Symbols Used .....	03
<b>2 Safety</b> .....	<b>04</b>
2.1 Important Safety Instructions .....	04
2.2 Explanation of Symbols .....	08
2.3 CE Directives .....	09
<b>3 Introduction</b> .....	<b>10</b>
3.1 Basic Features .....	10
3.2 Dimension.....	13
3.3 Terminals of Inverter .....	14
<b>4 Technical Data</b> .....	<b>13</b>
4.1 AC output/input .....	13
4.2 Internal Charger .....	14
4.3 Efficiency, Safety and Protection .....	14
4.4 General Data .....	15
<b>5. Installation</b> .....	<b>16</b>
5.1 Check for Transport Damage .....	16
5.2 Packing List .....	16
5.3 Mounting .....	17
<b>6 Electrical Connection</b> .....	<b>20</b>
6.1 Grid Connection .....	20
6.2 Battery Connection .....	22
6.3 Earth Connection .....	24

6.4 Meter/CT Connection(optional)..... 25

6.5 485 Connection ..... 28

6.6 DRM Connection ..... 28

6.7 WiFi Connection(optional) ..... 29

6.9 Inverter Manipulation ..... 30

**7 Firmware Upgrading ..... 32**

**8 Setting ..... 34**

8.1 Control Panel ..... 34

8.2 Menu Structure ..... 35

8.3 LCD Operation ..... 36

**9 Troubleshooting ..... 54**

9.1 Trouble Shooting ..... 54

9.2 Routine Maintenance ..... 58

**10 Decommissioning ..... 59**

10.1 Dismantling the Inverter ..... 59

10.2 Packaging ..... 59

10.3 Storage and Transportation ..... 59

# 1 Notes on this Manual

## 1.1 Scope of Validity

This manual is an integral part of X1-AC, It describes the assembly, installation, commissioning, maintenance and failure of the product. Please read it carefully before operating.

X1-AC-3.0	X1-AC-3.6	X1-AC-4.6	X1-AC-5.0
-----------	-----------	-----------	-----------

Note: **“3.0”** means 3.0kW.  
Store this manual where it will be accessible at all times.

## 1.2 Target Group

This manual is for qualified electricians. The tasks described in this manual only can be performed by qualified electricians.

## 1.3 Symbols Used

The following types of safety instructions and general information appear in this document as described below:



**Danger!**  
“Danger” indicates a hazardous situation which, if not avoided, will result in death or serious injury.



**Warning!**  
“Warning” indicates a hazardous situation which, if not avoided, could result in death or serious injury.



**Caution!**  
“Caution” indicates a hazardous situation which, if not avoided, could result in minor or moderate injury.



**Note!**  
“Note” provides tips that are valuable for the optimal operation of our product.

## 2 Safety

### 2.1 Important Safety Instructions



**Danger!**

**Danger to life due to high voltages in the inverter!**

- All work must be carried out by qualified electrician.
- The appliance is not to be used by children or persons with reduced physical sensory or mental capabilities, or lack of experience and knowledge, unless they have been given supervision or instruction.
- Children should be supervised to ensure that they do not play with the appliance.



**Caution!**

**Danger of burn injuries due to hot enclosure parts!**

- During operation, the upper lid of the enclosure and the enclosure body may become hot.
- Only touch the lower enclosure lid during operation.



**Caution!**

**Possible damage to health as a result of the effects of radiation!**

- Do not stay closer than 20 cm to inverter for any length of time.



**Warning!**

- Authorized service personnel must disconnect AC power from inverter before attempting any maintenance or cleaning or working on any circuits connected to inverter.



**WARNING !**

Do not operate the inverter when the device is running.



**WARNING !**

Risk of electric shock!

- Prior to the application, please read this section carefully to ensure correct and safe application. Please keep the user manual properly.
- Accessories only together with the inverter shipment are recommended here. Otherwise may result in a risk of fire, electric shock, or injury to person.
- Make sure that existing wiring is in good condition and that wire is not undersized.
- Do not disassemble any parts of inverter which are not mentioned in installation guide. It contains no user-serviceable parts. See Warranty for instructions on obtaining service. Attempting to service the inverter yourself may result in a risk of electric shock or fire and will void your warranty.
- The installation place should be away from humid or corrosive substance.
- Authorized service personnel must use insulated tools when installing or working with this equipment.
- Hazardous voltage will present for up to 5 minutes after disconnection from power supply.
- CAUTION-RISK of electric shock from energy stored in capacitor, Never operate on the inverter couplers, the MAINS cables or Battery cables when power is applied. After switching off the battery and Mains, always wait for 5 minutes to let the intermediate circuit capacitors discharge before unplugging battery inplug and MAINS couplers.
- When accessing the internal circuit of inverter, it is very important to wait 5 minutes before operating the power circuit or demounting the electrolyte capacitors inside the device. Do not open the device before hand since the capacitors require time to sufficiently discharge!
- Measure the voltage between terminals UDC+ and UDC- with a multi-meter (impedance at least 1Mohm) to ensure that the device is discharged before beginning work (35VDC) inside the device.
- To protect the AC system, surge suppression devices (SPD type2) should be fitted at the main incoming point of AC supply (at the customer's cutout), located between the inverter and the meter/distribution system; SPD (test impulse D1) for signal line according to EN 61632-1.

### ► Anti-Islanding Effect

- Islanding effect is a special phenomenon that grid-connected system still supply power to the nearby grid when the voltage loss is happened in the power system. It is dangerous for maintenance personnel and the public.
- X1-AC series inverter provide Active Frequency Drift(AFD) to prevent islanding effect.

### ► PE Connection and Leakage Current

- The inverter incorporates a certified internal Residual Current Device (RCD) in order to protect against possible electrocution and fire hazard in case of a malfunction in the cables or inverter. There are two trip thresholds for the RCD as required for certification (IEC 62109-2:2011). The default value for electrocution protection is 30mA, and for slow rising current is 300mA.
- If an external RCD is required by local regulations, check which type of RCD is required for relevant electric code. It recommends using a type-A RCD. The recommended RCD values is 100mA or 300mA unless a lower value is required by the specific local electric codes. When required by local regulations, the use of an RCD type B is permitted.



#### **WARNING !**

High leakage current!  
Earth connection essential before connecting supply.

- Incorrect grounding can cause physical injury, death or equipment malfunction and increase electromagnetic.
- Make sure that grounding conductor is adequately sized as required by safety regulations.
- Do not connect the ground terminals of the unit in series in case of a multiple installation. This product can cause current with a d.c component, Where a residual current operated protective (RCD) or monitoring (RCM) device is used for protection in case of direct or indirect contact, only the RCD or RCM of type B is allowed on the supply side of this product.

### For United Kingdom

- The installation that connects the equipment to the supply terminals shall comply with the requirements of BS 7671.
- No protection settings can be altered.
- User shall ensure that equipment is so installed, designed and operated to maintain at all times compliance with the requirements of ESQCR22(1)(a).

### For Australia and New Zealand

- Electrical installation and maintenance shall be conducted by licensed electrician and shall comply with Australia National Wiring Rules.

### ► Battery Safety Instructions

SolaX X1-AC Series inverter should be worked with high voltage battery, for the specific parameters such as battery type, nominal voltage and nominal capacity etc., please refer to section 4.2.

As accumulator batteries may contain potential electric shock and short-circuit current danger, to avoid accidents that might be thus resulted, the following warnings should be observed during battery replacement:



- 1: Do not wear watches, rings or similar metallic items.
- 2: Use insulated tools.
- 3: Put on rubber shoes and gloves.
- 4: Do not place metallic tools and similar metallic parts on the batteries.
- 5: Switch off load connected to the batteries before dismantling battery connection terminals.
- 6: Only personal with proper expertise can carry out the maintenance of accumulator batteries.

Note: The instruction applies to lithium battery and please refer to the lead-acid battery Quick Installation Guide.









## 2.2 Explanation of Symbols



This section gives an explanation of all the symbols shown on the inverter and on the type label.

### • Symbols on the Inverter

Symbol	Explanation
	The inverter is working normally, when the blue light is on.
	The battery communication is active, when the yellow light is on.
	An error has occurred, when the red light is on.

### • Symbols on the Type Label

Symbol	Explanation
	CE mark. The inverter complies with the requirements of the applicable CE guidelines.
	TUV certified.
	RCM remark.
	SAA certification.
	Beware of hot surface. The inverter can become hot during operation. Avoid contact during operation.
	Danger of high voltages. Danger to life due to high voltages in the inverter!
	Danger. Risk of electric shock!
	Observe enclosed documentation.

	The inverter can not be disposed together with the household waste. Disposal information can be found in the enclosed documentation.
	Do not operate this inverter until it is isolated from battery and main.
	Danger to life due to high voltage. There is residual voltage existing in the inverter after powering off, which needs 5 min to discharge. • Wait 5 min before you reoperate the inverter.

## 2.3 CE Directives

This chapter follows the requirements of the European low voltage directives, which contains the safety instructions and conditions of acceptability for the end user system, which you must follow when installing, operating and servicing the unit. If ignored, physical injury or death may follow, or damage may occur to the unit. Read this instructions before you work on the unit. If you are unable to understand the dangers, warnings, cautions or instructions, please contact an authorized service dealer before installing. Operating and servicing the unit.

The Grid connected inverter meets the requirement stipulated in Low Voltage Directive (LVD) 2014/35/EU and Electromagnetic Compatibility (EMC) Directive 2014/30/EU. The unit is based on:

EN 62109-1:2010 ; EN 62109-2:2011 ; IEC 62109-1(ed.1) ; IEC62109-2(ed.1)  
EN 61000-6-3:2007+A:2011 ; EN 61000-6-1:2007 ; EN 61000-6-2:2005

The grid connected inverter leave the factory completely connecting device and ready for connection to the mains, the unit shall be installed in accordance with national wiring regulations. Compliance with safety regulations depends upon installing and configuring system correctly, including using the specified wires. The system must be installed only by professional assemblers who are familiar with requirements for safety and EMC. The assembler is responsible for ensuring that the end system complies with all the relevant laws in the country where it is to be used.

The individual subassembly of the system shall be interconnected by means of the wiring methods outlined in national/international such as the national electric code (NFPA) No.70 or VDE regulation 0107.

## 3. Introduction

### 3.1 Basic features

X1-AC Seires is a high-quality inverter which can store energy into battery. The inverter can be used to optimize self consumption, store in the battery for future use or feedin to public grid. Work mode depends on the battery and user's preference.

- Advanced DSP control technology.
- Utilize the latest high-efficiency power component.
- Advanced anti-islanding solutions.
- IP65 protection level.
- Max. efficiency up to 97.0%.
- THD<2%.
- Safety & Reliability: transformerless design with software and hardware protection.
- Export control.
- Power factor regulation.
- Friendly HMI.
- LED status indications.
- LCD display technical data, Human-machine interaction through press key.
- Dry contact communication interface.
- Remote control via modbus RTU
- Upgrade through USB interface.
- Pocket Wi-Fi monitoring.
- Control loads' switch intelligently by RF.
- Energy conservation.

### 3.2 Dimension

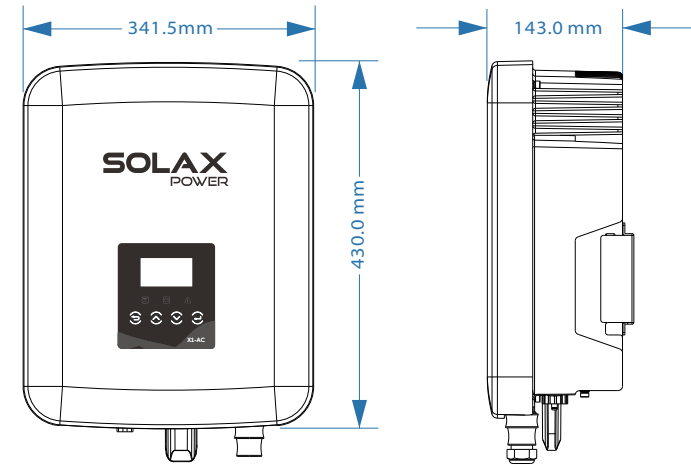

### 3.3 Terminals of inverter

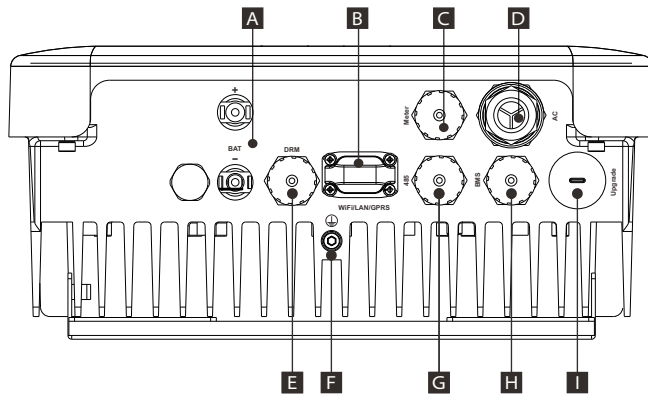

Object	Description
A	Battery connection area
B	Port for external Pocket WiFi/GPRS/LAN
C	External meter or CT port
D	AC connector
E	DRM port
F	Ground screw
G	RS485
H	Battery communication
I	USB port for upgrading

## 4. Technical Data

### 4.1 AC output/input

Model	X1-AC-3.0	X1-AC-3.6	X1-AC-4.6	X1-AC-5.0
<b>AC output</b>				
Normal AC power[VA]	3000	3680	4600	4999
Max. apparent AC power[VA]	3000	3680	4600	4999
Rated grid voltage(range)[V]	220/230/240 (180 to 280)			230/240 (180 to 280)
Rated grid frequency[Hz]	50/60			
Normal AC current[A]	13	16	20	21.7
Max.AC current[A]	13.6	16.8 (16 for G98)	21	21.7
Max. overcurrent protection[A]	45			
Displacement power factor	0.8 leading...0.8 lagging			
Total harmonic distortion(THDi)	< 2%			
Load control	optional			
<b>AC input</b>				
Normal AC power[VA]	3000	3680	4600	4999
Max. apparent AC power[VA]	3000	3680	4600	4999
Rated grid voltage(range)[V]	220/230/240 (180 to 280)			
Rated grid frequency[Hz]	50/60			
Normal AC current[A]	13	16	20	21.7
Max.AC current[A]	13.6	16.8 (16 for G98)	21	21.7
Max. short current(Isc)[A]	45			
Displacement power factor	0.8 leading...0.8 lagging			



#### WARNING !

Qualified electrician will be required for the installation.



## 4.2 Internal Charger

Model	X1-AC-3.0	X1-AC-3.6	X1-AC-4.6	X1-AC-5.0
Battery type	Lithium/Lead-acid battery			
Battery voltage range[V]	70-400			
Recommended battery voltage[V]	300VDC			
Rated charge/discharge current[A]	25A			
Max. charge/discharge current[A]	35A			
Communication interfaces	CAN			
Reverse connect protection	Yes			

## 4.3 Efficiency, Safety and Protection

Model	X1-AC-3.0	X1-AC-3.6	X1-AC-4.6	X1-AC-5.0
Max. efficiency	97.0%	97.0%	97.0%	97.0%
Max. Battery charge efficiency (AC to BAT)(@full load)	97.0%	97.0%	97.0%	97.0%
Max. Battery discharge efficiency (BAT to AC)(@full load)	97.5%	97.5%	97.5%	97.5%
<b>Safety &amp; Protection</b>				
Over/under voltage protection	YES			
DC isolation protection	YES			
Grid protection	YES			
DC injection monitoring	YES			
Residual current detection	YES			
Anti-islanding protection	YES			
Over load protection	YES			
Over heat protection	YES			

## 4.4 General Data

Model	X1-AC-3.0	X1-AC-3.6	X1-AC-4.6	X1-AC-5.0
Dimension [W/H/D](mm)	430*341.5*143			
Dimension of packing [W/H/D](mm)	554*446*259			
Net weight [kg]	15.5	15.5	16.3	16.3
Gross weight [kg]	18.5	18.5	19.3	19.3
Installation	Wall-mounted			
Operating temperature range[°C]	-25~+60 (derating at 45)			
Storage temperature [°C]	-25~+60			
Storage/Operation relative humidity	0~100%, condensing			
Altitude [m]	≤2000			
Ingress Protection	IP65(for outdoor use)			
Protective Class	I			
Over Voltage Category	III (MAINS), II (DC)			
Pollution Degree	III			
Cooling	Natural			
Inverter Topology	Non-isolated			
Communication interface	RS485, Meter/CT(optional), Wifi(optional), RF(optional), DRM, CAN, USB			

## 5. Installation

### 5.1 Check for Physical Damage

Make sure the inverter is intact during transportation. If there is any visible damage, such as cracks, please contact your dealer immediately.

### 5.2 Packing List

Open the package and take out the product, please check the accessories first. The packing list shown as below.

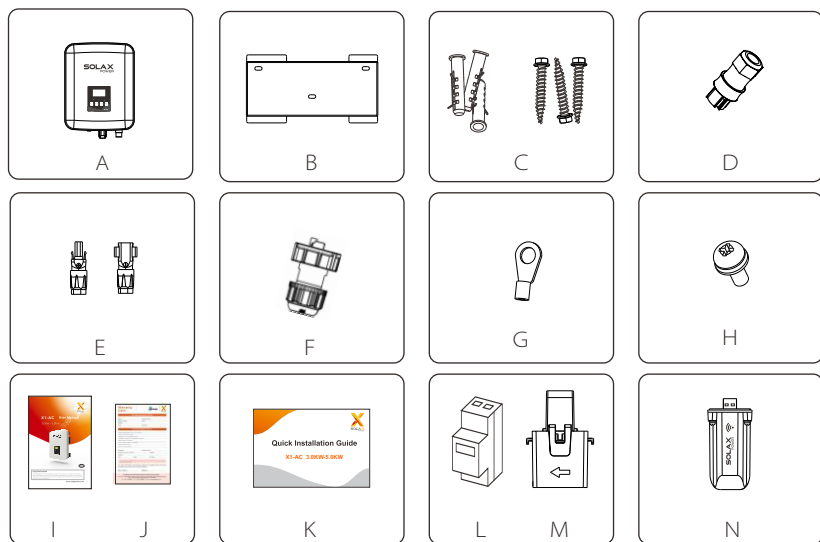

Object	Description
A	Inverter
B	Bracket
C	Expansion tubes & Expansion screws
D	AC connector
E	Battery connectors (1*positive, 1*negative)
F	Waterproof connector with RJ45 (4*RJ45)

Object	Description
G	Ring terminal(for external enclosure grounding)
H	Set screw( for mounting)
I	User manual
J	Warranty card
K	Quick installation guide
L	Meter(optional)
M	Current Sensor(or called CT) (optional)
N	Wifi/GPRS/LAN module (optional)

### 5.3 Mounting

#### ➤ Installation Precaution

X1-AC Series inverter is designed for outdoor installation (IP 65). Make sure the installation site meets the following conditions:

- Not in direct sunlight.
- Not in areas where highly flammable materials are stored.
- Not in potential explosive areas.
- Not in the cool air directly.
- Not near the television antenna or antenna cable.
- Not higher than altitude of about 2000m above sea level.
- Not in environment of precipitation or humidity (>95%).
- Under good ventilation condition.
- The ambient temperature in the range of -20°C to +60°C.
- The slope of the wall should be within  $\pm 5^\circ$ .
- The wall hanging the inverter should meet conditions below:
  - 1.Solid brick/concrete, or strength equivalent mounting surface;
  - 2.Inverter must be supported or strengthened if the wall's strength isn't enough(such as wooden wall, the wall covered by thick layer of decoration)

Please AVOIDE direct sunlight, rain exposure, snow laying up during installation and operation.

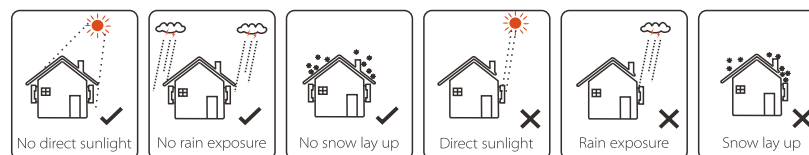

➤ Space Requirement

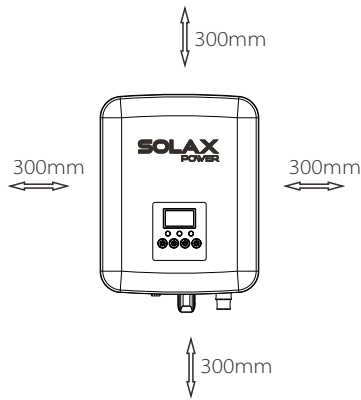

Table Available Space Size

Position	Min.size
Left	300mm
Right	300mm
Top	300mm
Bottom	300mm
Front	300mm

➤ Mounting Steps

Tools required for installation.

Installation tools : crimping pliers for binding post and RJ 45, screwdriver, manual wrench and  $\varnothing 6$  driller.

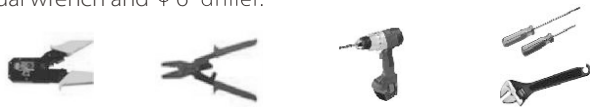

Step 1 Hang the inverter over the bracket, move the inverter close to it,

- Use the wall bracket as a template to mark the position of the 3 holes on the wall.
- Drill holes with driller, make sure the holes are deep enough (at least 50mm) for installation, and then tighten the expansion tubes.
- Install the expansion tubes in the holes, and tighten them. Then install the wall bracket by using the expansion screws.( $\varnothing 10$  driller, torque:  $2.5 \pm 0.2 \text{Nm}$ )

Step 2 Match the inverter with wall bracket

- Hang the inverter over the bracket, move the inverter close to it, slightly lay down the inverter, and make sure the 3 mounting bars on the back are fixed well with the 3 grooves on the bracket.

\*Please refer to the Quick Installation Guide for details.

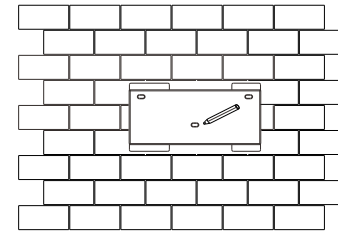

a)

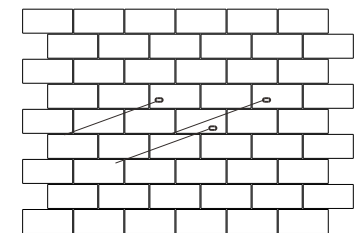

b)

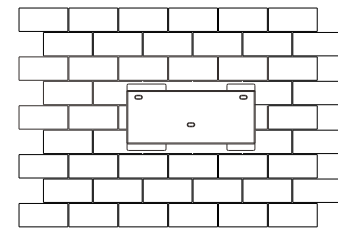

c)

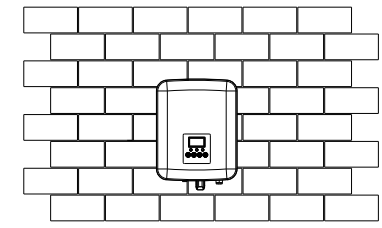

d)

## 6. Electrical Connection

### 6.1 Grid Connection

X1-AC series inverter are designed for single phase grid. Voltage is 220/230/240V, frequency is 50/60Hz. Other technical requests should comply with the requirement of the local public grid.

Table 4 Cable and Micro-breaker recommended

Model	X1-AC-3.0	X1-AC-3.6	X1-AC-4.6	X1-AC-5.0
Copper Cable	4-5mm <sup>2</sup>	4-5mm <sup>2</sup>	5-6mm <sup>2</sup>	5-6mm <sup>2</sup>
Micro-breaker	20A	20A	32A	32A

Micro-breaker should be installed between inverter and grid, any load should not be connected with inverter directly.

#### • Connection Steps

- Check the grid voltage and compare with the permissive voltage range (refer to technical data).
- Disconnect the circuit-breaker from all the phases and secure against re-connection.
- Trip the wires:
  - Trip all the wires to 52.5mm and the PE wire to 55mm.
  - Use the crimping plier to trip 6mm of insulation from the end of wire.

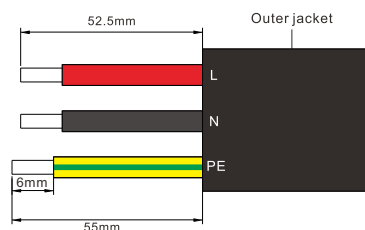

- Separate the AC plug into three parts as below.
  - Hold the middle part of the female insert, rotate the back shell to loose it, and detach it from female inset.
  - Remove the cable nut (with rubber insert) from the back shell.

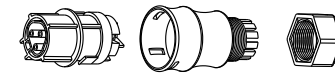

- Slide the cable nut and then back shell onto the cable.

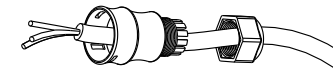

- Insert the tripped end of each three wires into the appropriate hole in the female insert, and then tighten each screw (to tighten each wire in place). (PH1 cross screwdriver, torque:  $0.8 \pm 0.1$  Nm)

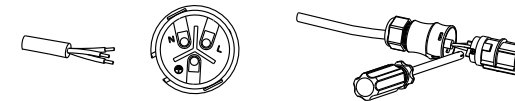

- Screw down the threaded sleeve the pressure screw.

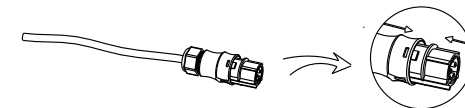

- Screw down the pressure screw. (torque:  $3.0 \pm 0.3$  Nm)

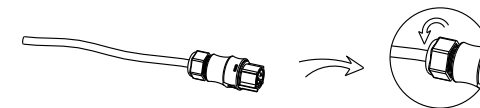

- Connect the AC plug to the inverter.

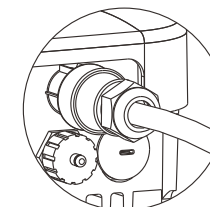

## 6.2 Battery Connection

Charging & discharging system of X1-AC series inverter is designed for high-voltage lithium battery or lead-acid battery. Before choosing battery, please note the maximum voltage of battery can not exceed 360V, and the battery communication should be compatible with X1-AC inverter.

### ➤ Battery breaker

Before connecting to battery, please install a **nonpolarized** DC breaker to make sure inverter can be securely disconnected during maintenance.

Model	X1-AC-3.0	X1-AC-3.6	X1-AC-4.6	X1-AC-5.0
Voltage	Nominal voltage of DC breaker should be larger than maximum voltage of battery.			
Current[A]	50A			

### ➤ Battery connection diagram

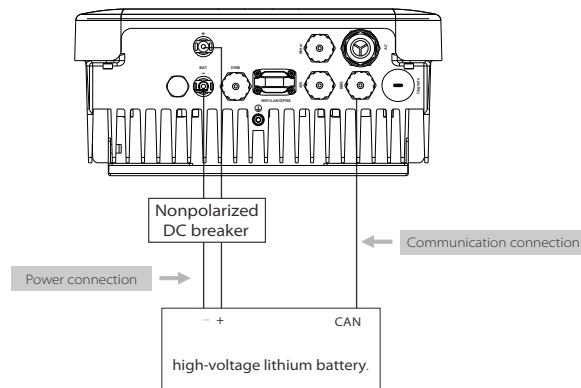

Note: When working with Pylontech batteries, It is recommended the number of battery module (H48050-15S) is 2-6 and the number of battery manager system (SC0500A-100S) is 1.

### ➤ BMS PIN Definition

Communication interface between inverter and battery is CAN with a RJ45 connector.

	1	2	3	4	5	6	7	8
BMS	NTC	GND	GND	BMS_CANH	BMS_CANL	GND	BMS_485A	BMS_485B



### Note!

The battery communication can only work when the battery BMS is compatible with the inverter.

### ➤ Power Connection Steps:

**Step1.** Choose the 10 AWG wire and strip the cable to 15mm.

**Step2.** Insert the stripped cable up to the stop (negative cable for DC plug(-) and positive cable for DC socket(+)) are live). Hold the housing on the screw connection.

**Step3.** Press down spring until it clicks audibly into place.(it must be possible to see the fine wire strands in the chamber)

**Step4.** Tighten the screw connection(tighten torque:2.0±0.2Nm)

**Step5.** Plug the connector into the corresponding BAT connector on inverter.

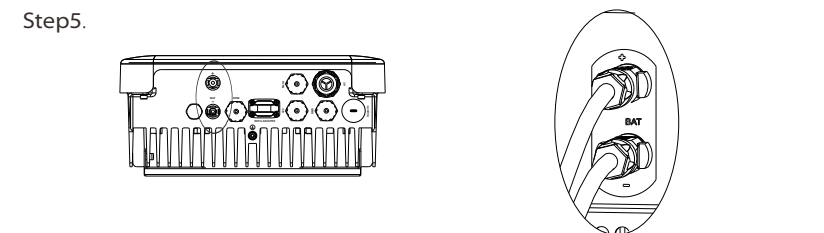
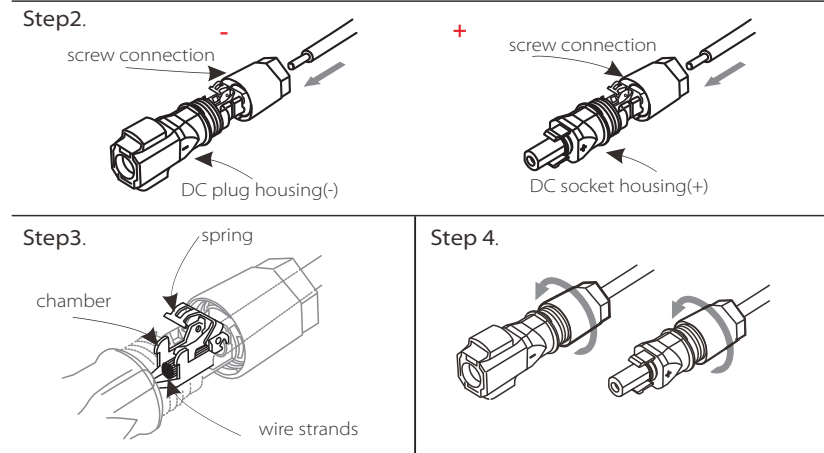

Note: The positive line and negative line are not allowed to access anti-Line.

### 6.3 Earth Connection (mandatory)

Users must additionally earth the inverter to the enclosure of a second earthing or equipotential bonding. This prevents electric shock if the original protective conductor fails.

➤ **Earth Connection Steps:**

**Step1.** Strip the earthing cable insulation and insert the stripped cable into the ring terminal, then clamp it .

**Step2.** Place the ring terminal into the earthing rod and screw the earthing screw tightly.(  $\Phi 4$  hexagon wrench, torque:  $1.5 \pm 0.2\text{Nm}$ )

**Step1**

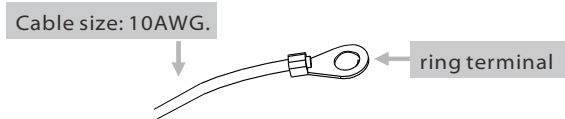

**Step2**

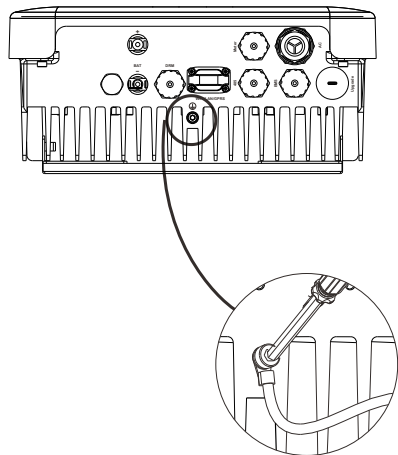

### 6.4 Meter/CT Connection

➤ **Meter connection**

Meter is used for monitoring the power usage for entire house, at the meantime, inverter will also need the data from Meter to achieve the Export Control Function.

**Note!**  
 It is necessary to connect meter to inverter otherwise inverter will shutdown with a "Meter fault" alert.  
 The meter communication only works when meter is compatible with the inverter.

• **Meter connection diagram**

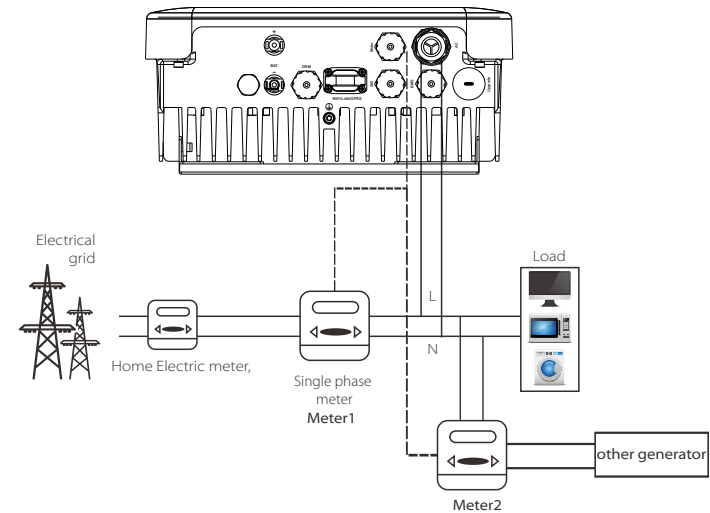

• **Meter PIN Definition**

Communication interface between inverter and meter is BMS port with a RJ45 connector.

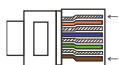
	1	2	3	4	5	6	7	8
	X	X	X	X	X	GND	485A	485B

• **Meter Connection Steps:**

Please refer to Page 27.

➤ CT Connection Steps:

The current sensor measures the current on the phase wire that runs between the inverter and the grid. This enables the inverter to determine the Power requirements of the connected consumer. The current sensor is connected to the CT port on the inverter.

**NOTE!**



- Do not place the sensor on the N Wire or the earth wire.
- Do not place the sensor on the N and L wire simultaneously.
- Do not place the sensor on the L wire going to the consumer.
- Do not place the sensor with the arrow pointing to the generation meter.
- Do not place the sensor on the non-insulated wires.
- Do not use the wire over 25m.

**NOTE!**



- The sensor can be upgraded to meter.
- With a one phase meter provided by SolaX can monitoring the 24hr usage of electric.
- With a three phase meter provided by SolaX can implement three phase compensation.

• CT connection diagram

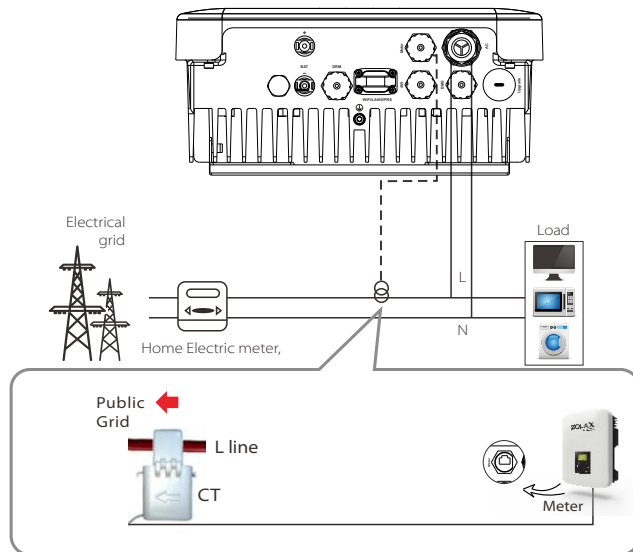

• CT PIN Definition

When connecting the RJ45 connector with the wire of the CT, please follow the below sequence :

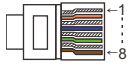

1	2	3	4	5	6	7	8
CT+	X	X	CT-	X	X	X	X

• CT Connection Steps:

1. Insert the CT terminal on the current sensor into the Meter port on the inverter.

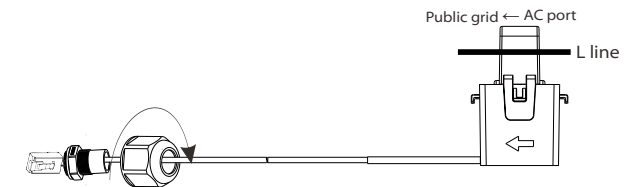
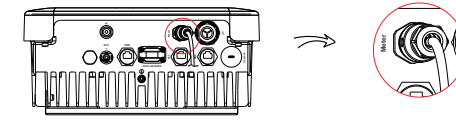

2. Place the current sensor around the phase wire L which the inverter is connected.
3. Place the current sensor around the phase wire L to measure the current going to or coming from the grid.
4. Make sure the current sensor is installed in the right direction: The arrow on the current sensor must point to the public grid.

### 6.5 485 Connection

485 is provided the function of remote control that allows external control device to make the inverters remote cluster control through 485 port on the inverter.

➤ **485 PIN Definition:**

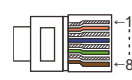
	1	2	3	4	5	6	7	8
	COM0	Shut Down	GND	485A	485B	X	X	X

➤ **485 Connection Steps:**

Please refer to the bellow(Page 28).

### 6.6 DRM Connection

DRM is provided to support several demand response modes by emitting control signals as below through DRM port on the inverter.

*Note: Only PIN6(DRM0) is available now, and other PIN functions are being developed.*

➤ **DRM PIN Definition:**

	1	2	3	4	5	6	7	8
	DRM1/5	DRM2/6	DRM3/7	DRM4/8	+3.3V	DRM0	GND	GND

➤ **Communication Connection Steps Of Meter, RS485 and DRM:**

Please kindly noted the PIN definition and port position will be slightly different.

1. Prepare RJ45 connector and a communication cable.
2. Trip the insulation from the communication cable.
3. Let the communication cable pass through the waterproof connector with RJ45, then insert it into the RJ45 connector following the PIN definition rule.

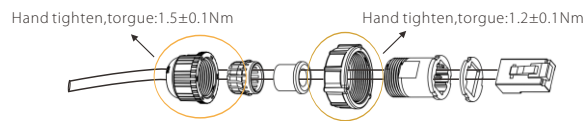

4. Crimp the RJ45 connector with the crimping plier.
5. Insert the cable into the corresponding port of the inverter, and tighten the waterproof connector.

### 6.7 WiFi Connection(optional)

Inverter provides a WiFi port which can collect data from inverter and transmit it to monitoring-website via a Pocket WiFi. (Purchase the product from supplier if needed)

➤ **Diagram**

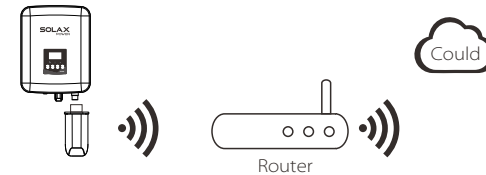

➤ **WiFi Connection Steps:**

- Step1.** Plug Pocket Wifi/GPRS/LAN into “WiFi/LAN/GPRS” port at the bottom of the inverter.
- Step2.** Build the connection between the inverter and router.
- Step3.** Create a user account on the SolaX web.( Please check the Pocket WiFi user manual for more details)(torque:0.6±0.1Nm)

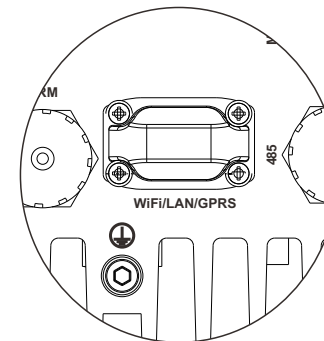



## 6.8 Inverter Manipulation

### ➤ Start inverter after checking all below steps:

- ❶ Ensure the inverter fixed well on the wall.
- ❷ Make sure all the AC wirings are completed.
- ❸ Make sure the meter is connected well.
- ❹ Make sure the battery is connected well.
- ❺ Turn on the AC and battery switch.
- ❻ Press the "Enter" key for five seconds to exit Off Mode.(The mode is factory defaulted as Off Mode)

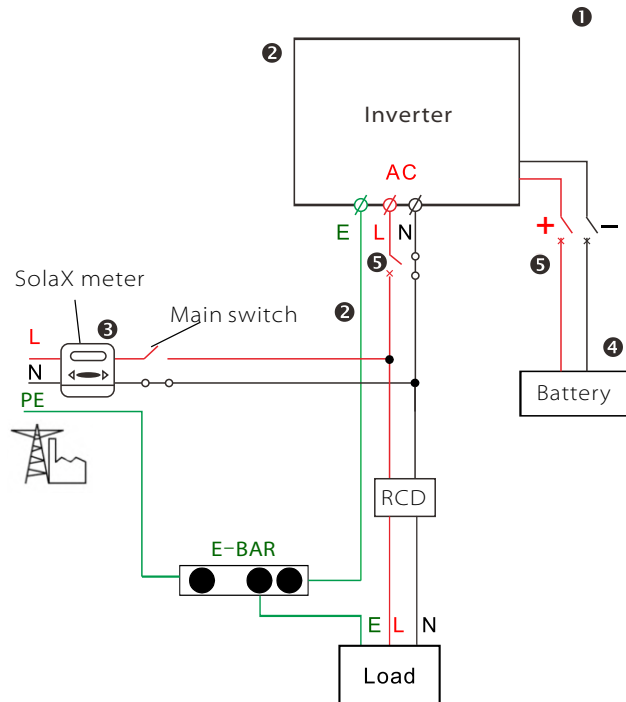

Note: External connections should be made according to the local regulations.

### ➤ Check the inverter:

**Step1.** Check the status of indicators and LCD screen. The left indicator should be blue and the indicator screen should display the main interface.

**Note !**

 If the left indicator is not blue please check below the two points:

- All the connections are correct.
- All the external breakers are switched on.

**Step2.** There is a setting guide on the LCD screen if it is the first time to start up, please follow it. For specific setting, please refer to section 8 (Setting).

**Step3.** Set WiFi according to wifi user manual.

**Step4.** Operate "Self Test". (applies to Italy only)

### ➤ Self-test in accordance with CEI 0-21 (applies to Italy only)

The self-test is only required for inverters, which are commissioned in Italy. The Italian standard requires that all inverters feeding into the utility grid are equipped with a self-test function in accordance with CEI 0-21. During the self-test, the inverter will consecutively check the protection reaction times and values for overvoltage, undervoltage, overfrequency and underfrequency.

Selftest function is available at any time, and the test report will show on the LCD display for end-user.

### ➤ Shut down the inverter :

All you have to do is turn off the AC switch and battery switch.

## 7. Firmware Upgrading

User can upgrade inverter's firmware via a U-disk.

### ➤ Preparation

Please ensure the inverter is steadily powered on.  
 Inverter must keep the battery on through whole procedure of upgrading.  
 Please prepare a PC and a U-disk.



**Warning!**

Make sure the inverter charged normally (the battery capacity is stable), otherwise it may result in **serious failing** during upgrading.

### ➤ Upgrading Steps:

**Step1.** Please contact our service support to get the update files, and extract it into your U-disk as follow:

*"update\ARM\618.00211.00\_X1AC\_Manager\_Vx.xx\_xx-xx.usb";*

*"update\DSP\618.00209.00\_X1AC\_Master\_Vx.xx\_xx-xx.hex";*

*Note: Vx.xx is version number, xx-xx is the file completion date.*



**Warning!**

Make sure the directory is in accordance with above form strictly!  
 Do not modify the program file name, or it may cause the inverter not work anymore!

**Step2.** Press the "Enter" key for 5 seconds to enter Off Mode. Then unscrew the waterproof lid and insert U-disk into the "upgrade" port at the bottom of the inverter.

**Step3.** The LCD will be shown as the picture bellow. Then press up and down to select the one that you want and press "OK" to confirm to upgrade.

**Step4.** After the upgrade is finished, the LCD will display "succeed"(only for DSP upgrades), please remember to pull off the U-disk, screw the waterproof lid and press the "Esc" to return to the Main interface. Then press the "Enter" key to exit Off Mode.

### Step2

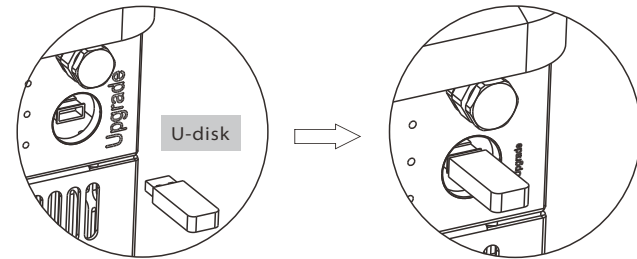

### Step3

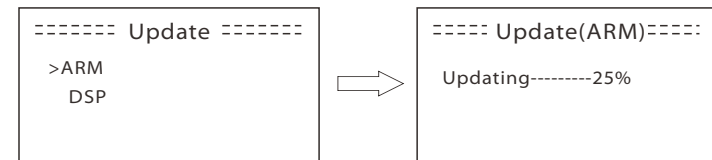

**Warning!**

If the upgrading is broken off during operation, please ensure the inverter is steadily powered on and reinsert the U-disk.

# 8. Setting

## 8.1 Control Panel

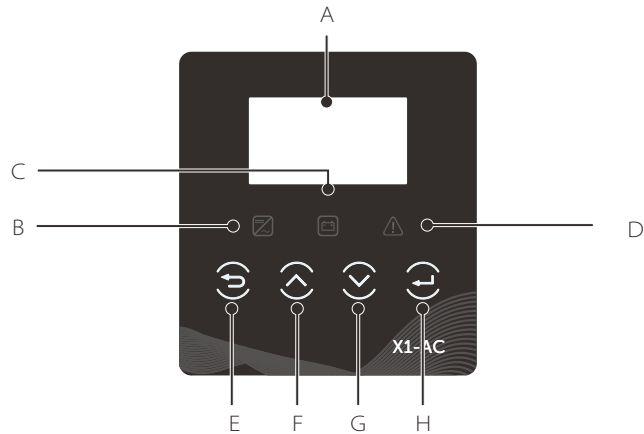

Object	Name	Description
A	LCD Screen	Display the information of the inverter.
B	Indicator LED	Light in blue: The inverter is in normal status. Flash in blue: The inverter is in waiting status.
C		Light in yellow: The battery communication is normal. Flash in yellow: The battery is in idle mode.
D		Light in red: The inverter is in fault status.
E		Function Button
F	Up button: Move cursor to upside or increase value.	
G	Down button: Move cursor to downside or decrease value.	
H	OK button: Confirm the selection.	

## 8.2 Menu Structure

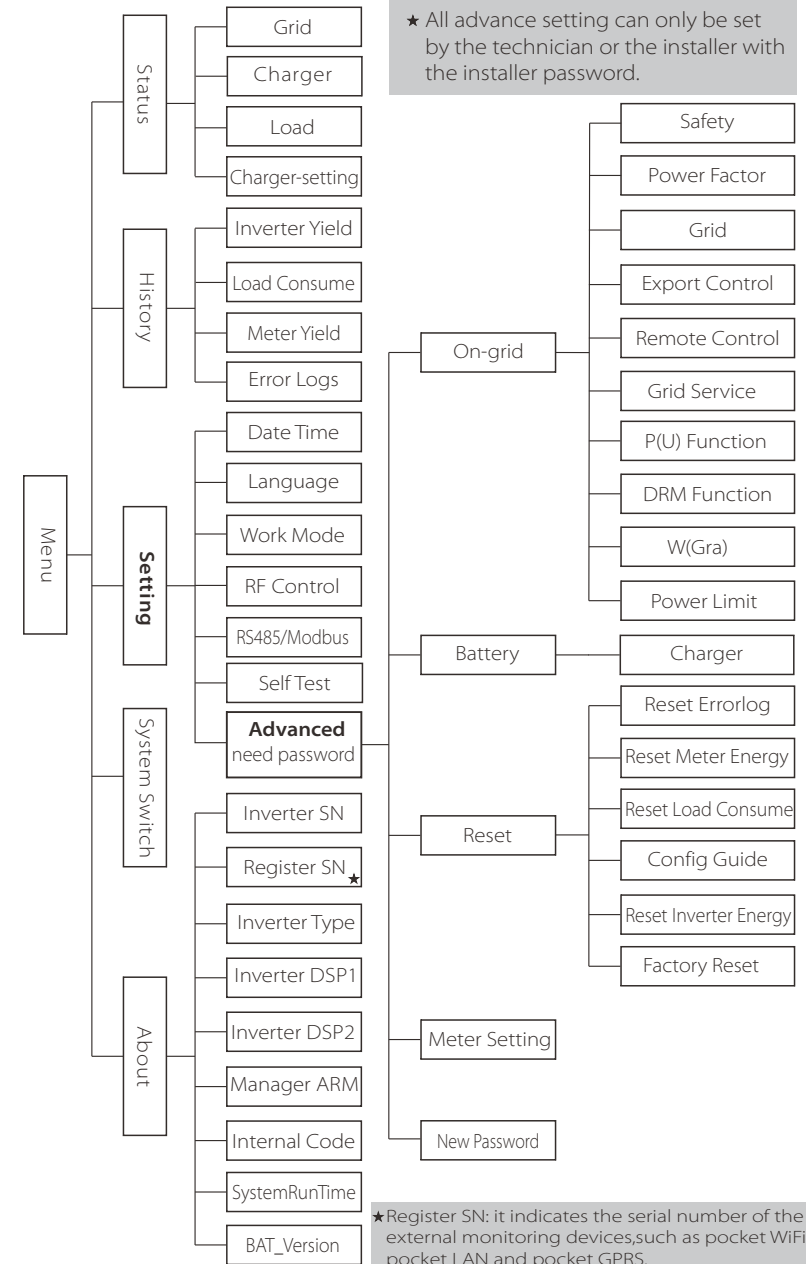

### 8.3 LCD Operation

#### LCD Digital Display

The main interface is the default interface, the inverter will automatically jump to this interface when the system started up successfully or not operated for a period of time.

The information of the interface is as below. "Power" means the instant output power; "Today" means the power generated within the day. "Battery" means the left capacity of lithium battery energy(%) shown as the table, while the unit of lead-acid battery is voltage(V).

Power	0W
Today	0.0KWh
Battery	%
Normal	

#### Menu interface

The menu interface is a transfer interface for user to get into another interface to change the setting or getting the information.

-User can get into this interface by pressing "OK" button when LCD displays the main interface.

-User can select interface by moving the cursor with function button, and press "OK" to confirm.

Menu
Status
History
Settings

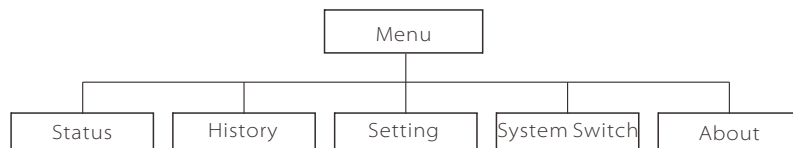

#### ➤ Status

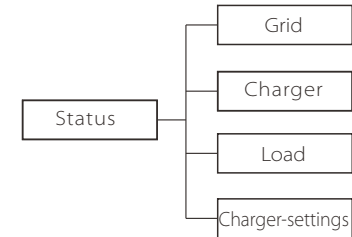

#### ● Status

The status function contains three items of the inverter(grid, charger and Load). Press up and down to select and press "OK" to confirm the selection, press "ESC" to return to Menu.

Status
Grid
Charger
Load

#### a) Grid

This status shows the current grid condition such as voltage, current, output power, the local consumed power and the frequency.

Pout measures the output of the inverter;

Pgrid measures power export to or import from grid.

Positive value means the energy feeds into grid, negative value means the energy used from the grid.

Grid	
U	000.0V
I	00.0A
Pout	00.0W

b) Charger

This status shows the charger situation of the system, including the battery voltage, charge or discharge current and power, battery capacity, battery temperature(“+” means in charging;“-” means in discharging) and system voltage.

Charger	
U	100.0V
I	+1.0A
P	+100W

c) Load

If the inverter is plugged with a smart plug, this status shows the real time load power, include load1 power, load1 switch, load2 power and load2 switch.

Load	
>L1 Power	0.0W

c) Charger-Settings

The user can watch the parameters (min capacity, max charge current and max discharge current) of the lead-acid battery, if the user choose the lead-acid battery.

ChargerSettings	
>Min Capacity	20%

ChargerSettings	
Imax_charge	35A

Chargersettings	
Imax_discharge	35A

➤ History

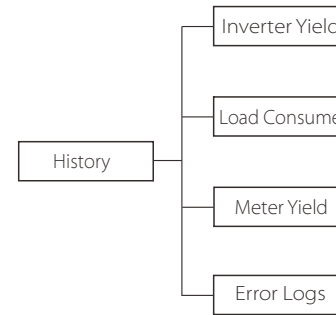

● History

The history function contains four items of the information: Inverter yield, load consume, meter yield and error logs.

Press up and down to select, and press “OK” to confirm the selection, press “ESC” to return to Menu.

History	
Inverter Yield	
Load Consume	
Meter Yield	

a) Inverter Yield

This Inverter Yield contains four items: OutputGridToday, OutputGridTotal, InputGridToday and InputGridTotal.

Inverter Yield	
>OutputGridToday	0.8KWh

b) Load consume

The Load consume contains the energy consumed by specific loads by today and total.

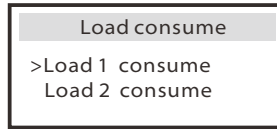

c) Meter Yield

The Meter Yield contains four items: FeedInToday, FeedInTotal, ConsumeToday and ConsumeTotal.

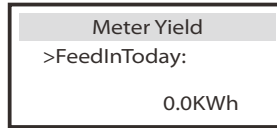

d) Error Logs

The Error logs record the lastest six error messages happened.

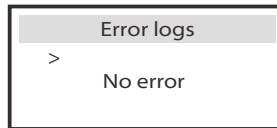

➤ Setting

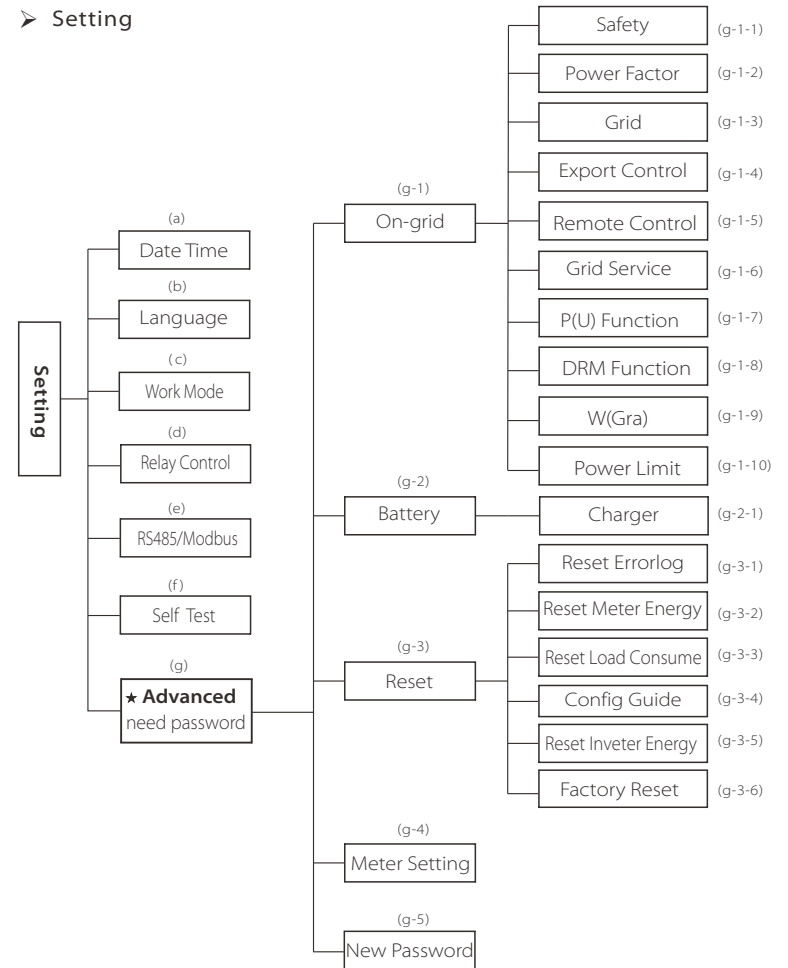

● Setting

This function is used for setting the time, connection, battery, grid and others below of the inverter.

Enduser can set Date Time, Language, Woke Mode, Relay Control and RS485CommAddr directly.

But for advanced setting, it requires installer password to operate most of the professional settings.

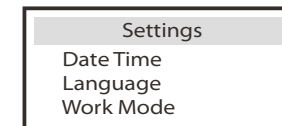

a) Date Time

This interface is for user to set the system date and time.

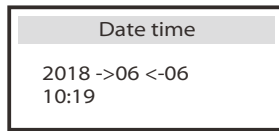

b) Language

This inverter provides the languages for customer to select.

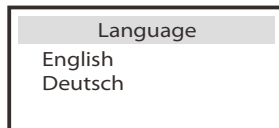

c) Work Mode

There are 4 work modes for choice.

Users can set the modes such as Self Use, Feedin Priority, Back up Mode and Force Time Use.

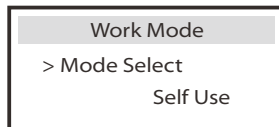

Parameter	Comment
Self Use (default)	Because there is no PV supplied, battery will discharge for local loads firstly, and grid will supply power when the battery capacity is not enough.
Back Up Mode	Battery will stop discharging to keep higher capacity when the grid is on. Only when the grid is off is not enough, battery will start to discharge to keep the emergency load working normally. This work mode applies to the area where suffering from blackout regularly.
Feed in Priority	The priority of inverter output power is: feeding to the grid → supplying the load → charging the battery. This work mode applies to the area with high feed-in tariff.
Force Time Use	In this work mode the charging and discharging time can be set flexibly, and it also allows to choose whether charge from the grid or not.

- For "Force Time Use" mode, there are 4 parameters that needs to be set.

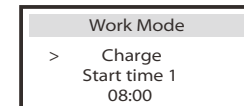
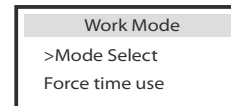

Parameter	Comment
Charger start time1	The start time of the first charger period.
Charger end time1	The end time of the first charger period.
Charger start time2	The start time of the second charger period.
Charger end time2	The end time of the second charger period.

d) RF Control

RF Control is an optional function which can control designated load intelligently by consuming the surplus energy when feed in power reaches certain value.

This function can only be achieved with solax product "Smart Plug". For specific operation, please refer to "Smart Plug user manual".

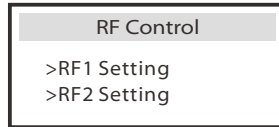

e) RS485/MODBUS

User can set the baud rate (9600, 14400, 19200, 38400, 56000, 57600 and 115200) and modbus communication address (1~255).

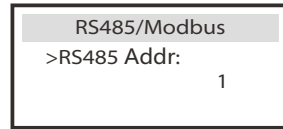
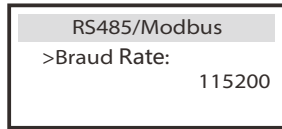

f) Self Test (applies to CEI 0-21 only)

User can test operating status of inverter by choosing "Start Test". It will turn back to the Home page automatically and shows "SelfTesting...". 60 seconds later, it will display "success", which means selftest completed successfully. Then it will turn back to the "Test Report" page as below automatically and shows specific parameters.

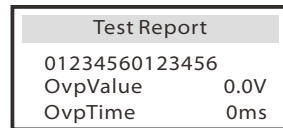
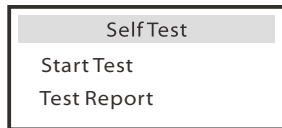

g) Advanced

All the advanced settings can be set here, such as battery, grid, meter and so on. "Advanced" is divided into five parts: On-grid, Battery, Parallel Setting, Reset, Meter Setting and New Password. And every part has lower level parts. Please contact with your installer or factory for the installer password to enter.

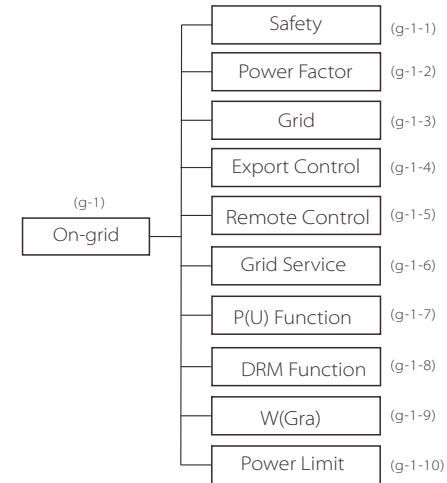
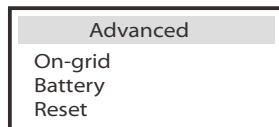

g-1-1) Safety

User can set safety standard according to different countries and grid tied standards. There are 8 standards to select. (May change without notice)

Item	Standard	Country
1	VDE 0126	German
2	ARN 4015	German
3	AS 4777	Australia
4	G83/2	UK
5	G59/3	UK
6	EN 50438_NL	Netherlands
7	CEI 0-21	Italy
8	IEC61727_In	India

g-1-2) Power Factor (For specific country if required by the local grid.)

There are 6 modes for selecting: Off, Lagging, Leading, Curve, Q(u) and Fixed Q Power.

Mode	Comment
Off	-
Lagging	PF value
Leading	PF value
Curve	Upper limit
	Lower limit
	Power Upper
	Power Lower
	PFLockInPoint (CEI 0-21 only)
Q(u)	PFLockOutPoint (CEI 0-21 only)
	QuVupRate (EN50438_NL only)
Fixed Q Power	QuVlowRate (EN50438_NL only)
	Q Power



**Reactive power control, Reactive standard curve  $\cos \varphi = f(P)$**

For VDE ARN 4105, curve  $\cos \varphi = f(P)$  should refer to curve A. default value of setting is as shown in curve A.

For E 8001, curve  $\cos \varphi = f(P)$  should refer to curve B. default value of setting is as shown in curve B.

For CEI 0-21, default value of PFLockInPoint is 1.05, when  $V_{ac} > 1.05V_n$ , and  $P_{ac} > 0.2 P_n$ , curve  $\cos \varphi = f(P)$  should refer to curve C. Default value of PFLockOutPoint is 1, when  $V_{ac} < 1 V_n$ ,  $\cos \varphi = f(P)$  will exit curve C.

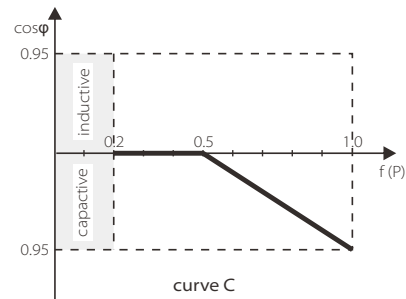
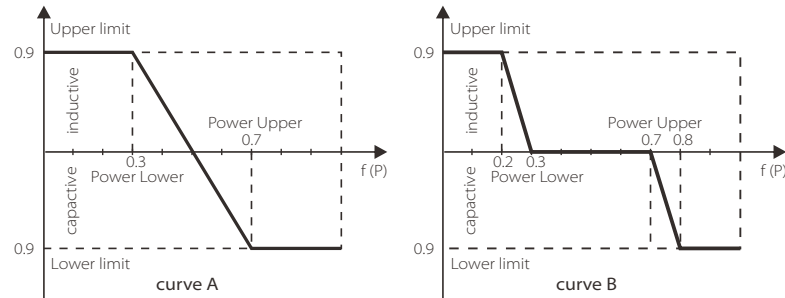

**Reactive power control, Reactive standard curve  $Q = f(V)$**

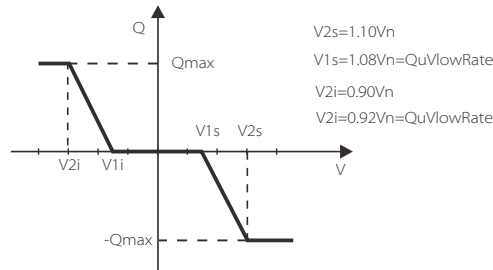

**g-1-3) Grid**

The enduser do not need to set the grid parameters. All default value has set on factory according to safety rules.

If need to reset, any changes should according to the requirement of local grid.

Parameter	Comment
<b>Normally</b>	
Vac upper	Voltage high protect
Vac lower	Voltage low protect
Vac upper slow	Voltage high slow protect
Vac lower slow	Voltage low slow protect
Fac upper	Frequency high protect
Fac lower	Frequency low protect
Fac upper slow	Frequency high slow protect
Fac lower slow	Frequency low slow protect
Vac 10m avg	10 min voltage high protect
<b>Apply to Italy(CEI0-21) only.</b>	
Tuvp_Fast	Overvoltage protect fast time
Tovp_Fast	Undervoltage protect fast time
Tufp_Fast	Overfrequency protect fast time
Tofp_Fast	Underfrequency protect fast time
Tuvp_Slow	Overvoltage protect slow time
Tovp_Slow	Undervoltage protect slow time
Tufp_Slow	Overfrequency protect slow time
Tofp_Slow	Underfrequency protect slow time
FreDrpDlyTime	Frequency droop delay time
<b>Apply to EN50438_NL only.</b>	
FreqSetPoint	Frequency set point
FreqDropRate	Frequency droop rate

**g-1-4) Export control**

This function allows the inverter able to control energy. There are user value and factory value. The factory value is default which can not be changed by user. The user value setting by installer must be less than the factory value.

Choose "Disable" means the function will be shut off.

**Export Control**

User value:  
4000W

## g-1-5) Remote Control

Remote control function allows external control device to make the inverter remote cluster control through 485 port on the inverter. And it can control the inverter's active power output and reactive power output.

The default value is "enable". Choose "disable" means the function is turn off.

If you have the requirement, please feel free to let us know.

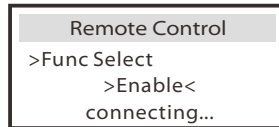

## g-1-6) Grid Service(applies to CEI 0-21)

Grid Service can be selected from "Enable" or "Disable". The default is "Enable".

According to the requirements for the safety of battery storage inverter is different. some may be opposite to the rights of the user. User can select "Disable" to turn off these features if user receives legal permission.

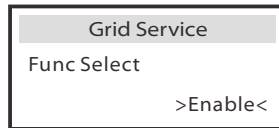

## g-1-7) P(U) Function(For specific country if required by the local grid)

P(U) function is volt-watt response mode which is required by some specific country standard such as AS4777.2.

"Enable" is the default value and means this function is turned on.

Choose "Disable" means the function will be shut off.

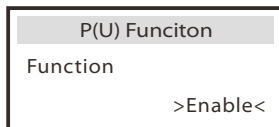

## g-1-8) DRM Function(applies to NZS4777.2)

DRM function is Demand Response Mode which is required by standard NZS4777.2 and applies to NZS4777.2 only.

The default value is "enable". Choose "disable" means the function is turned off.

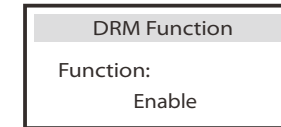

## g-1-9) W(Gra) (applies to NZS4777.2)

W(Gra) is Gradient of power rate limit which is required by standard NZS4777.2 and applies to NZS4777.2 only. This function is defined as a percentage of rated power per minute.

The default value is "enable". Choose "disable" means the function is turned off.

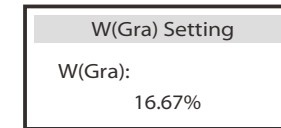

## g-1-10) Power Limit

The user can set the power limit of the inverter(0.0~1.0)

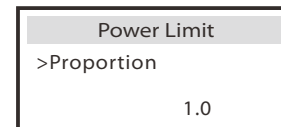



g-2-1) Charger

Here the user can see the type (lithium or lead-acid) of the battery and can set the parameters of min capacity, charge max current and discharge max current. For the detailed parameters, please refer to below table.

➤ For Lithium battery

<b>Charger</b> >Min Capacity 20%	<b>Charger</b> Charge Max Current 30A	<b>Charger</b> Discharge Max Current 30A
--	---	--

➤ For Lead-acid-battery

<b>Charger</b> Charge Absorp Voltage 0.0V	<b>Charger</b> Charge Float Voltage 0.0V	<b>Charger</b> Discharge cut Voltage 0.0V
<b>Charger</b> Charge Max Current 0.0A	<b>Charger</b> Discharge Max Current 0.0A	

(1) When the battery voltage reaches the value( discharge cut voltage for lead-acid battery, min capacity for lithium battery) in on-grid mode(no PV power), battery will stop discharging and the system will go into IDLE mode.

(2) The way to exit from "BAT power low".

-Press ESC button can exit from "BAT power low" manually.

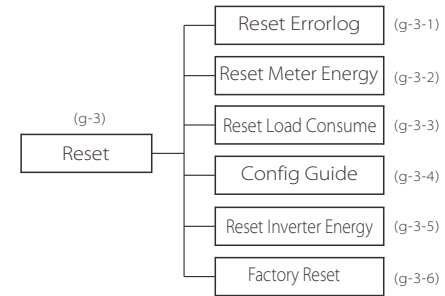

g-3-1) Reset Errorlog

User can reset all inverter errorlog record here.

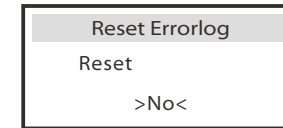

g-3-2) Reset Meter Energy

User can reset the meter energy record here.

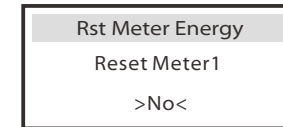

g-3-3) Reset Load Consume

User can reset the specific load's energy if the inverter is installed with a smart plug.

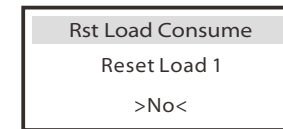

g-3-4) Config guide

This interface will trigger the initial setting guide reset again.

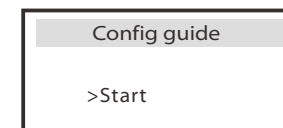

g-3-5) Reset Inverter Energy

User can reset the inverter energy records here.

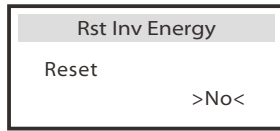

g-3-6) Factory Reset

User can reset the factory settings to the original state.

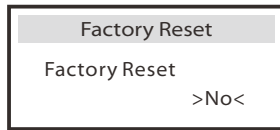

g-4) Meter Setting

X1-AC inverter needs to work with Energy meter to achieve the functions.

User also can turn off meter function so that X1-AC inverter can work as normal grid-tied inverter without meter connected.

In hybrid system, if there is other power device in the system to be monitored, It can install two meters to monitor both solax inverter and other power device. These two meters need to be set different to address. Address 001 and address 002 are default and will be written to meters in factory.

So user do not need to change the address except specific situation.

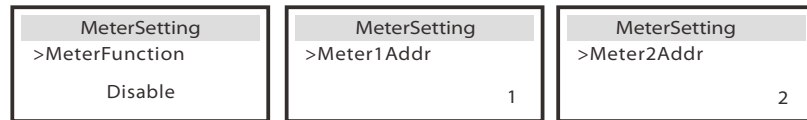

g-5) New Password

User can set the new password here.

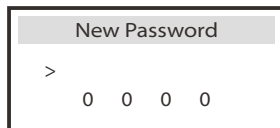

➤ System Switch

● "System Switch" can be chosen from "ON" or "OFF".

"ON" means that the inverter is in working condition and which is default status. "OFF" means that the inverter stop delivering all power, but the LCD remains on.

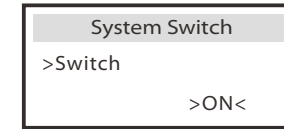

Long press "Enter" key can also switch on "System Switch" "ON" or "OFF".

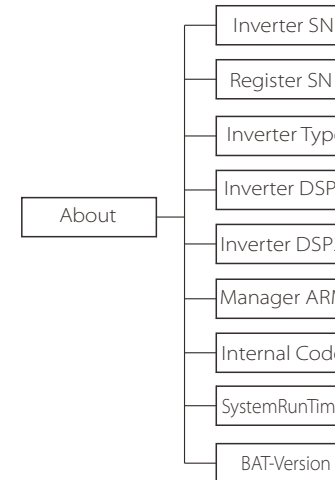
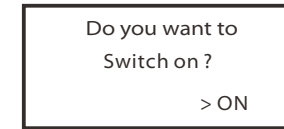

★ Register SN: it indicates the serial number of the external monitoring devices, such as pocket WIFI, pocket LAN and pocket GPRS.

➤ About

● This interface shows information of the inverter including inverter serial number, register serial number, inverter type, inverter DSP1, inverter DSP2, manager ARM, internal code, system run time and bat\_version (The master and the slave versions of the our supplied battery).



## 9. Troubleshooting

### 9.1 Trouble shooting

This section contains information and procedures for solving possible problems with X1-AC inverters, and provides you with troubleshooting tips to identify and solve most problems that could occur with the X1-AC inverters.

This section will help you narrow down the source of any problems you may encounter. Please read the following troubleshooting steps.

Check warnings or fault messages on System Control Panel or Fault codes on the inverter information panel. If a message is displayed, record it before doing anything further.

Attempt the solution indicated in below table.

Faults	Diagnosis and solution
TZ Protect Fault	Over current Fault. <ul style="list-style-type: none"> <li>• Wait for a while to check if go back to normal status.</li> <li>• Disconnect battery and reconnect it.</li> <li>• Or seek help from us, if can not go back to normal state.</li> </ul>
Grid Lost Fault	Grid is Lost. <ul style="list-style-type: none"> <li>• Please wait for a while and system will reconnect if the utility is back to normal.</li> <li>• Please check whether the cable connection at AC side is normal or not.</li> <li>• Or seek help from us.</li> </ul>
Grid Volt Fault	Grid Voltage Out of Range <ul style="list-style-type: none"> <li>• Please wait for a while and system will reconnect if the utility is back to normal.</li> <li>• Please check whether the grid voltage is in the normal range.</li> <li>• Or seek help from us.</li> </ul>
Grid Freq Fault	Grid Frequency Out of Range <ul style="list-style-type: none"> <li>• System will reconnect if the utility is back to normal.</li> <li>• Or seek help from us.</li> </ul>
Meter Fault	Meter Fault. <ul style="list-style-type: none"> <li>• Please check if the meter is abnormal working.</li> <li>• Or seek for help from us if can not go back to normal.</li> </ul>
Bus Volt Fault	Bus Voltage Out of Normal Range <ul style="list-style-type: none"> <li>• Disconnect battery, reconnect it.</li> <li>• Or seek help from us, if can not go back to normal state.</li> </ul>
Bat Volt Fault	Battery Voltage Fault <ul style="list-style-type: none"> <li>• Check if the battery input voltage.is within the normal range</li> <li>• Or seek help from us.</li> </ul>

Faults	Diagnosis and solution
AC10M Volt Fault	The grid voltage is out of range for the last 10 Minutes. <ul style="list-style-type: none"> <li>• The system will back to normal if the grid is back.</li> <li>• Or seek for help from us.</li> </ul>
DCI OCP Fault	DCI over current protection Fault. <ul style="list-style-type: none"> <li>• Wait for a while to check if back to normal.</li> <li>• Or seek for help from us.</li> </ul>
SW OCP Fault	Over current fault detected by software. <ul style="list-style-type: none"> <li>• Wait for a while to check if back to normal.</li> <li>• Turn off the battery and grid , reconnect them.</li> <li>• Or seek for help from us.</li> </ul>
RC OCP Fault	DCI over current protection Fault. <ul style="list-style-type: none"> <li>• Please check if the insulation of electric wires are damaged.</li> <li>• Wait for a while to check if back to normal.</li> <li>• Or seek for help from us.</li> </ul>
Isolation Fault	Isolation Fault <ul style="list-style-type: none"> <li>• Please check if the insulation of electric wires are damaged.</li> <li>• Wait for a while to check if back to normal.</li> <li>• Or seek for help from us.</li> </ul>
Temp Over Fault	Temperature over the limitation <ul style="list-style-type: none"> <li>• Check if the envirement temperature is over limitation.</li> <li>• Or seek help from us.</li> </ul>
BatConDir Fault	Battery Reverse Connection Fault <ul style="list-style-type: none"> <li>• Check if the positive pole and negtive pole of battery are connected in a contrary way</li> <li>• Or seek help from us.</li> </ul>
Sample Fault	The detection circuit Fault <ul style="list-style-type: none"> <li>• Disconnect battery, reconnect it.</li> <li>• Or seek help from us.</li> </ul>
BMS Lost	BMS Communication Lost <ul style="list-style-type: none"> <li>• Check if the BMS cable is loose or broken.</li> <li>• Or seek help from us, if can not go back to normal state.</li> </ul>
Inter Com Fault	Internal Communication Fault <ul style="list-style-type: none"> <li>• Turn off the battery and grid , reconnect them.</li> <li>• Or seek help from us, if can not go back to normal state.</li> </ul>
Fan Fault	Fan Fault <ul style="list-style-type: none"> <li>• Turn off the battery and grid , reconnect them.</li> <li>• Or seek help from us, if can not go back to normal state.</li> </ul>
AC HCT Fault	AC Current Sensor Fault <ul style="list-style-type: none"> <li>• Turn off the battery and grid , reconnect them.</li> <li>• Or seek help from us, if can not go back to normal state.</li> </ul>

Faults	Diagnosis and solution
Inv EEPROM Fault	Inverter EEPROM Fault • Turn off the battery and grid , reconnect them. • Or seek help from us, if can not go back to normal state.
RCD Fault	Residual Current Device Fault • Check the impedance of AC output. • Disconnect battery, reconnect it. • Or seek help from us, if can not go back to normal state.
Grid Relay Fault	Grid Relay Fault • Disconnect grid and battery, reconnect them. • Or seek help from us, if can not go back to normal state.
OtherDevideFault	Other Devide Fault • Disconnect grid and battery, reconnect them. • Or seek help from us, if can not go back to normal state.
Mgr EEPROM Fault	Manager EEPROM Fault. • Turn off the battery and grid , reconnect them. • Or seek for help from us if can not back to normal.
BMS_External_Err	Battery Fault-external fault • Please contact battery supplier.
BMS_TemHigh	Battery Fault-over-temperature fault • Please contact battery supplier.
BMS_TemLow	Battery Fault-under-temperature fault • Please contact battery supplier.
BMS_CellImblance	Battery Fault-cell imbalance fault • Please contact battery supplier.
BMS_Internal_Err	Battery Fault-intarnal fault • Please contact battery supplier.
BMS_OverVoltage	Battery Fault-overvoltage fault • Please contact battery supplier.
BMS_LowerVoltage	Battery Fault-undervoltage fault • Please contact battery supplier.
BMS_ChargeOCP	Battery Fault-charge overcurrent fault • Please contact battery supplier.
BMS_DischargeOCP	Battery Fault-discharge overcurrent fault • Please contact battery supplier.

- If your inverter's information panel is not displaying a Fault light, check the following list to make sure that the present state of the installation allows proper operation of the unit.
  - Is the inverter located in a clean, dry, adequately ventilated place?
  - Are the cables adequately sized and short enough?
  - Are the input and output connections and wiring in good condition?
  - Are the configurations settings correct for your particular installation?
  - Are the display panel and the communications cable properly connected and undamaged?

Contact SolaX Customer Service for further assistance. Please be prepared to describe details of your system installation and provide model and serial number of the unit.

## 9.2 Routine maintenance

Inverters do not need any maintenance or correction in most conditions, but if the inverter often loses power due to overheating, this can be the following reason:

- The cooling fins on the rear of the house are covered by dirt.

Clean the cooling fins with a soft dry cloth or brush if necessary.

**Only trained and authorized professional personnel who are familiar with the requirements of safety are allowed to perform servicing and maintenance work.**

### ➤ Safety checks

Safety checks should be performed at least every 12 months, please contact the manufacturer to arrange a qualified person who has adequate training, knowledge, and practical experience to perform these tests. (Please kindly note this action is not covered by warranty). The data should be recorded in an equipment log. If the device is not functioning properly or fails any of the tests, the device has to be repaired. For safety check details, refer to this manual, section 2 Safety instruction and EC Directives.

### ➤ Maintain Periodically

Only qualified persons may perform the following works.

During the process of using the inverter, the manager shall examine and maintain the machine regularly. The concrete operations are as follows.

1: Check that if the cooling fins on the rear of the house are covered by dirt, and the machine should be cleaned and absorb dust when necessary. This work shall be checked from time to time.

2: Check that if the indicators of the inverter are in normal state, check if the keys of the inverter are in normal state, check if the display of the inverter is normal. This check should be performed at least every 6 months.

3: Check that if the input and output wires are damaged or aged. This check should be performed at least every 6 months.

4: You should keep the inverter panels clean and their security checked at least every 6 months.

## 10. Decommissioning

### 10.1 Remove the Inverter

- Disconnect the inverter from DC Input and AC output.
- Wait for 5 minutes for de-energizing.
- Disconnect communication and optional connection wirings.
- Remove the inverter from the bracket.
- Remove the bracket if necessary.

### 10.2 Packaging

Please pack the inverter with the original packaging.

If the original package is no longer available, you can also use an equivalent carton that meets the following requirements.

- Suitable for loads more than 30 kg.
- With handle.
- Can be fully closed.

### 10.3 Storage and Transportation

Store the inverter in a dry environment where ambient temperature keeps always between -20 °C - +60 °C. Take care of the inverter during the storage and transportation, keep less than 4 cartons in one stack.

When the inverter or other related components need to be disposed, have it carried out according to local waste handling regulations. Please be sure to deliver wasted inverters and packing materials to a certain site, where can assist relevant department to dispose and recycle.

